

 Genuine Accessories

TK1 Side Step (Board Type)

Installation Manual

Parts List

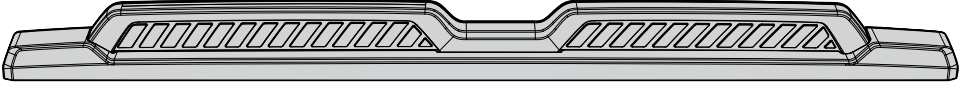

Side Step RH
(1EA)

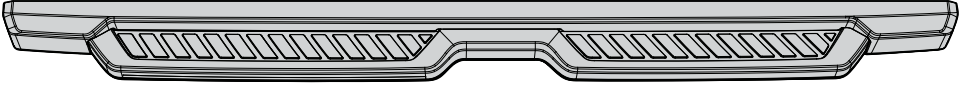

Side Step LH
(1EA)

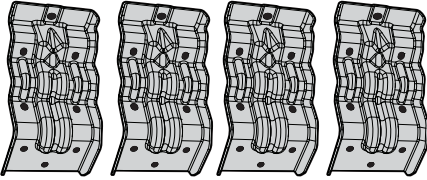

NO.1 BRKT
(4EA)

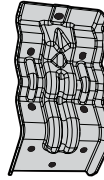

NO.2 BRKT LH
(1EA)

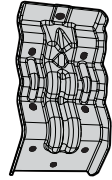

NO.2 BRKT RH
(1EA)

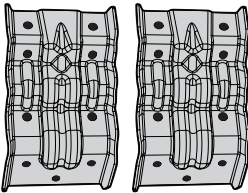

NO.3 BRKT
(2EA)



M8x20 Bolt
(66EA)



Installation Manual

Installation tool



IPA



Clean Cloth

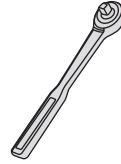

Ratchet

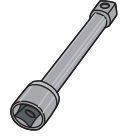

Connecting Tool

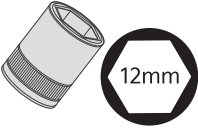

Socket
(12mm)



Torque Wrench



Clip Remover

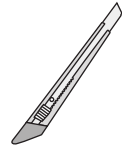

Cutter



Clean Gloves



Safety Goggles



Safety Shoes

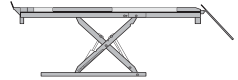

Vehicle Lift



Caution

※ Precautions for installing side step

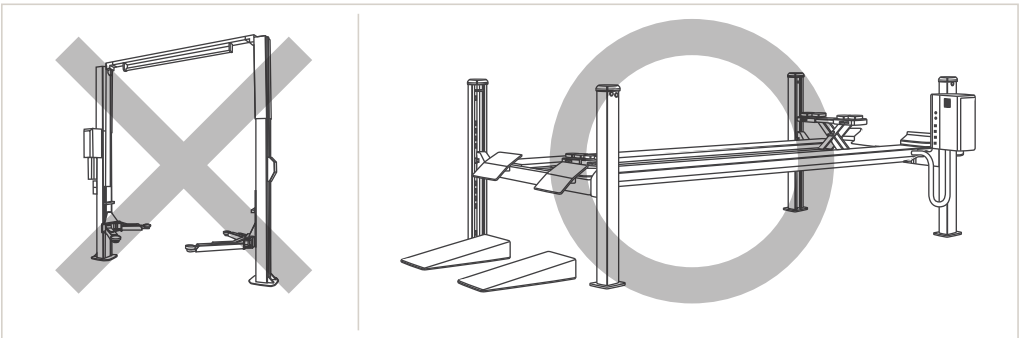

- ※ Do NOT use a two-post vehicle lift for side step installation.
- ※ Please proceed with the installation work in pairs.
- ※ Please pay special attention to physical injuries when handling side step.
- ※ Be sure to read and understand the precautions for use of the side step.
- ※ The manufacturer is not responsible for accidents, physical injuries, damage to the product, or financial loss in case of failure to comply with installation and precautions for use.

Installation

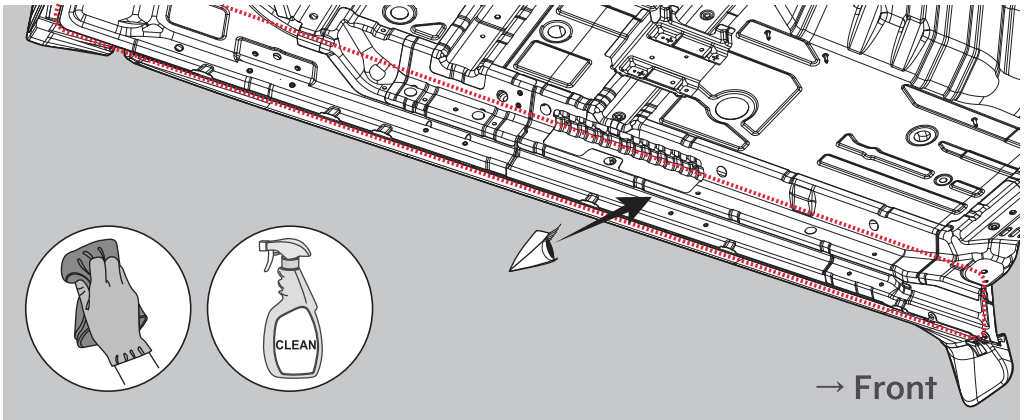

1. Use IPA to clean the lower part of the LH direction of the vehicle where the product will be installed.

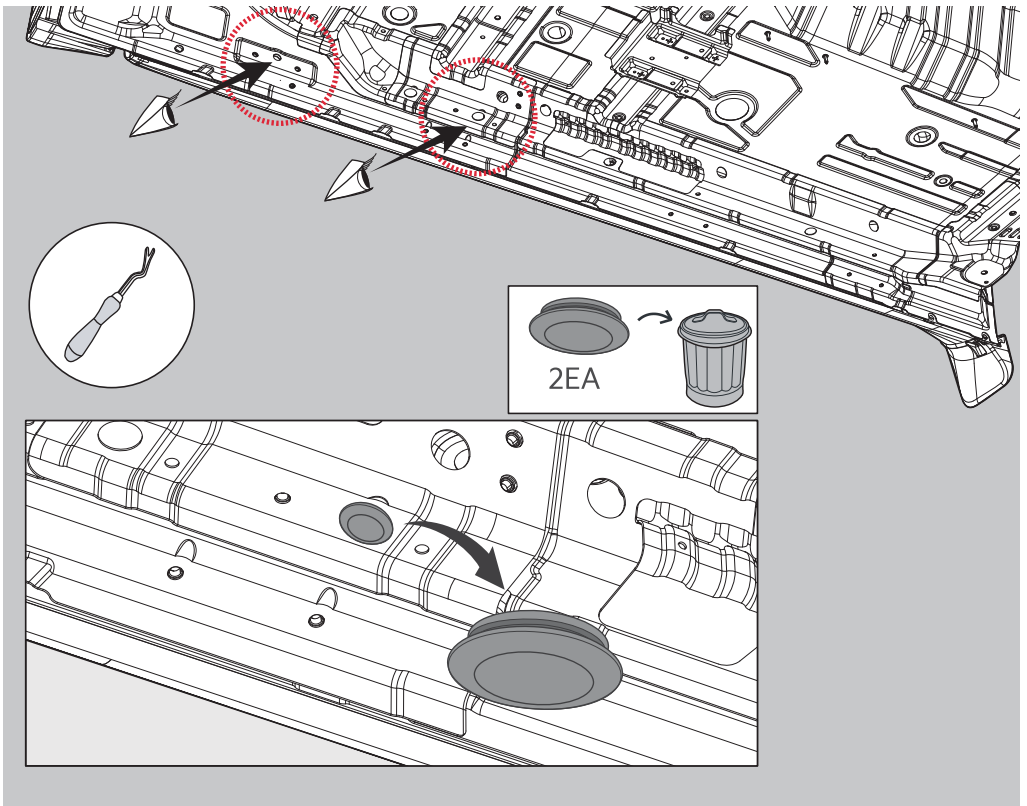

2. Remove the two rubber caps located at the bottom of the vehicle using a clip remover.

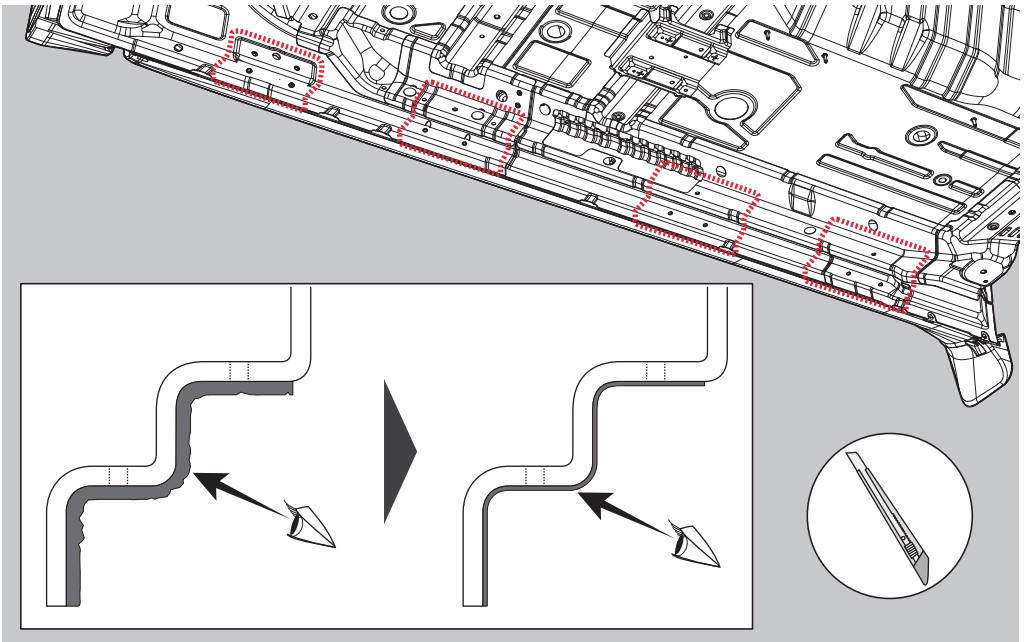

3. Using a cutter, shave away any high points of the sealant at lower panel.
 ※ Work evenly so that the remaining sealant remains 1mm inside.
 ※ When removing the sealant, be careful not to damage the body.

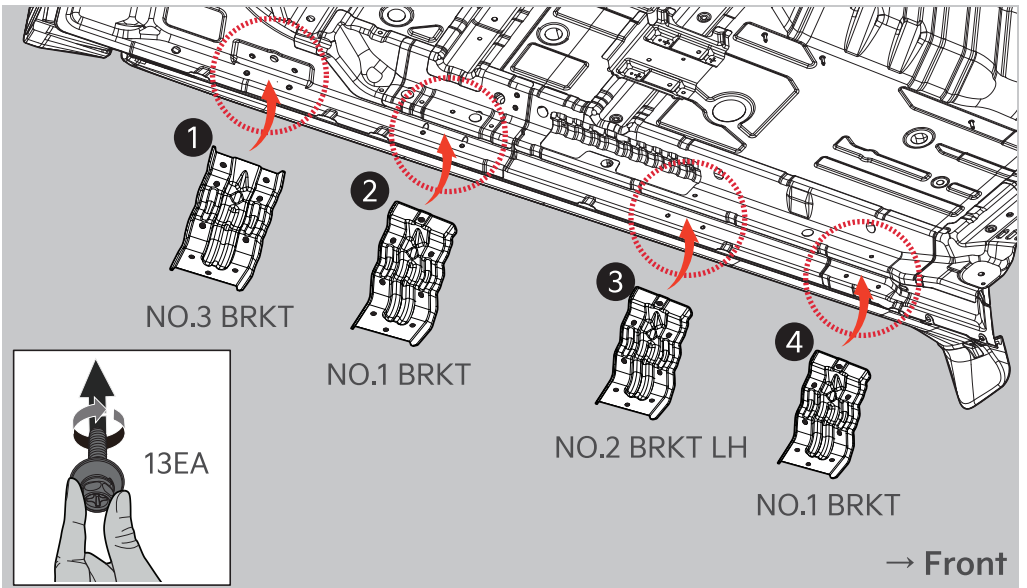

4. Use the M8x20 bolt to temporarily fasten the four BRKT to the lower panel.
 ※ Please check the number and direction written on BRKT.

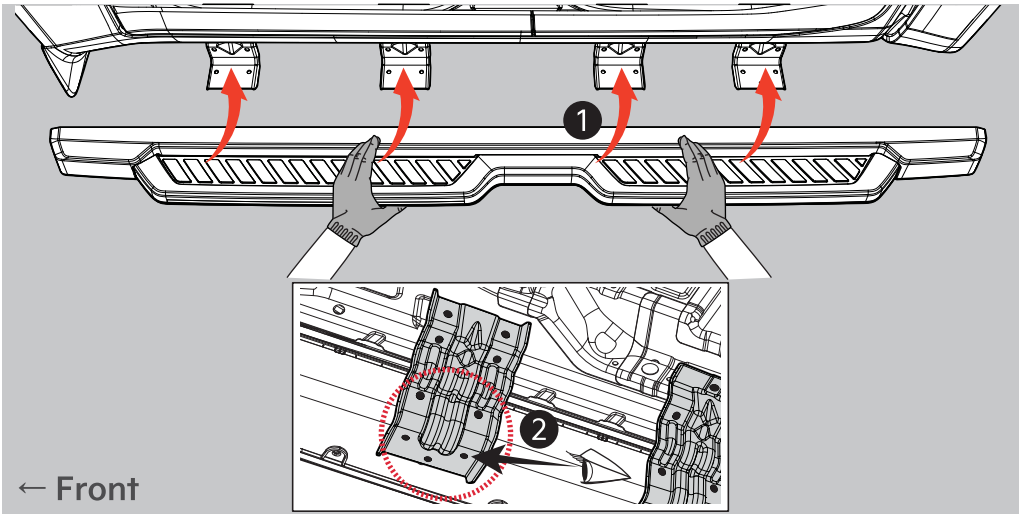

5. Place the bottom hole of the side step in the correct position to match the hole of the BRKT.

- ※ Please check the position of the hole at the bottom of the side step.
- ※ Please pay attention to the side step LH/RH direction.
(Front footrest is wider than rear footrest)

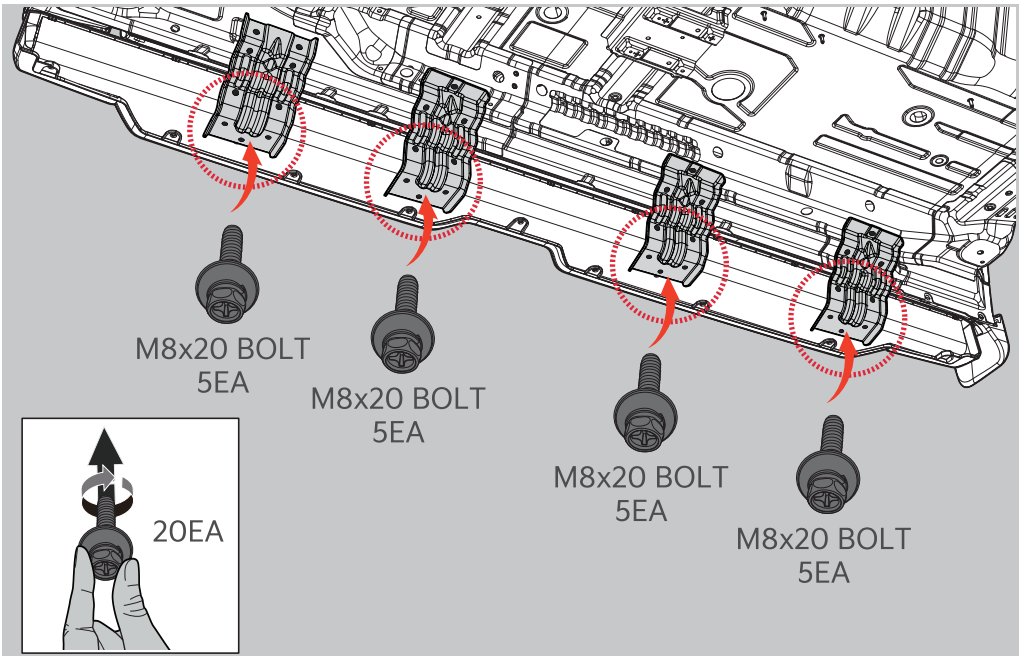

6. Using the M8x20 bolt, temporarily fasten the side steps to the four BRKT.

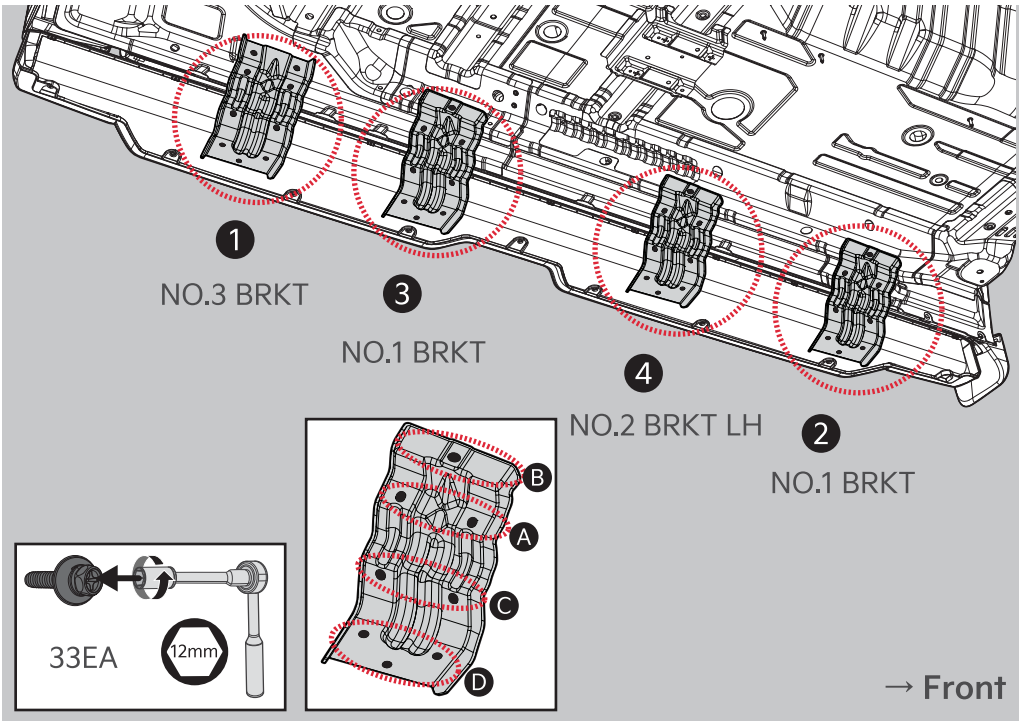

7. Fasten the 33 M8*20 bolts have been temporarily fastened in order.

※ Fasten the BRKT in accordance with the bolt fastening procedures A, B, C, and D.

※ BRKT Fastening Order : ① NO.3 BRKT located at the rear

② NO.1 BRKT located in the front

③ NO.1 BRKT located in the center

④ NO.2 BRKT LH located in the center

※ M8x20 bolts reference torque value is 16.0 N, cm, and 14.6 lbf, 141.6.

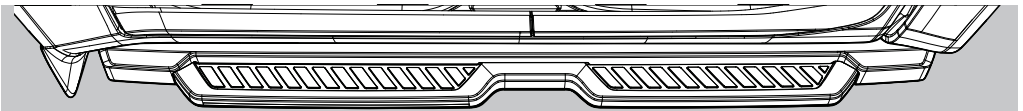

8. Install the passenger area (RH) in the same process.

9. Use IPA to clean the side step.

10. Installation is complete.

Caution

- This product is for "Board Type" only.
- Do not arbitrarily damage, modify, or transform the product.
- When using, do not apply excessive force and be careful because sharp objects may damage the product.
- When cleaning the product, wipe it with a clean cloth.
- We are not responsible for accidents, breakdowns and damages caused by consumer carelessness and negligence.

Matters to be marked according to safety/display standards

Product Name: Side Step

Key Specifications: Board Type

Size : 2267×288×193 (mm)

Country of production : Republic of Korea

Date of production : Box marked separately

Manufacturer : AIA Co., Ltd.

Product Quality Guarantee

- Only product defects can be exchanged, and damage or damage caused by careless handling is excluded from the warranty.
(Warranty period: 1 year from the date of purchase)